

## ■ 特徵

- TBU系列的端子盤可配在TBR-N導軌上。
- 採用框式壓線,材料為經淬火硬化並經鍍鋅鈍化的優質鋼板。
- 可搭配適合的短路片及標示牌,產品的設計符合IEC60947-7-1等國際標準。

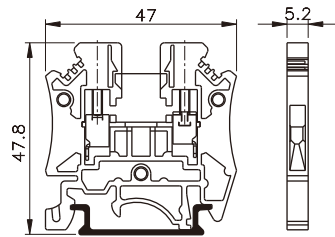

TBU-2.5N

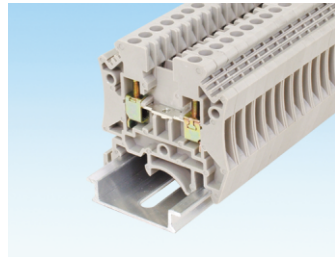

TBU-4N

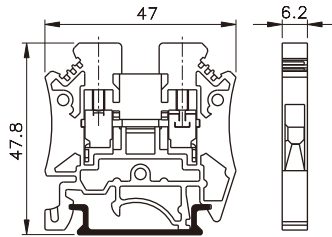
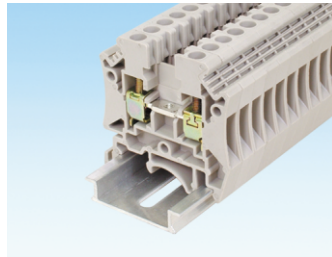

TBU-6N

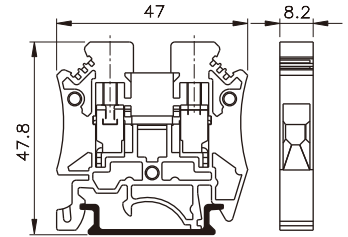
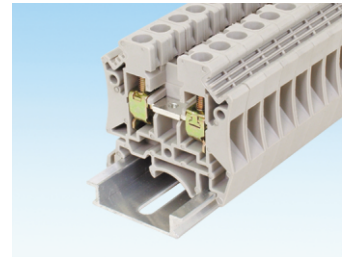

規格
額定電流
額定電壓
電線截面積
單芯線
多芯線
耐電壓
扭力
螺絲
剝線長度
配件
標示牌
擋片
側蓋
適用導軌
上連接片
側連接片

IEC	型號	包裝數
24A	TBU2.5N-A	100
800V	TBU2.5N-F	50
2.5mm <sup>2</sup>	TBU2.5N-H	100
22-12AWG	TBR-N(鋁)/TBR-S(鋼)	1M/條
22-12AWG	TBU2.5N-CU2	2P 50
5KV	TBU2.5N-CU3	3P 50
4kgf.cm	TBU2.5N-CU4	4P 50
M2.6	TBU2.5N-CU10	10P 20
10~12mm	TBU2.5N-CS2	2P 50
	TBU2.5N-CS3	3P 50
	TBU2.5N-CS4	4P 50
	TBU2.5N-CS10	10P 20

IEC	型號	包裝數
32A	TBU4N-A	100
800V	TBU2.5N-F	50
4mm <sup>2</sup>	TBU2.5N-H	100
22-10AWG	TBR-N(鋁)/TBR-S(鋼)	1M/條
22-10AWG	TBU4N-CU2	2P 50
22-10AWG	TBU4N-CU3	3P 50
5KV	TBU4N-CU4	4P 50
6kgf.cm	TBU4N-CU10	10P 20
M3	TBU4N-CS2	2P 50
10~12mm	TBU4N-CS3	3P 50
	TBU4N-CS4	4P 50
	TBU4N-CS10	10P 20

IEC	型號	包裝數
41A	TBU6N-A	100
800V	TBU2.5N-F	50
6mm <sup>2</sup>	TBU2.5N-H	100
20-8 AWG	TBR-N(鋁)/TBR-S(鋼)	1M/條
20-8 AWG	TBU6N-CU2	2P 50
5KV	TBU6N-CU3	3P 50
10kgf.cm	TBU6N-CU4	4P 50
M3.5	TBU6N-CU10	10P 20
10~12mm	TBU6N-CS2	2P 50
	TBU6N-CS3	3P 50
	TBU6N-CS4	4P 50
	TBU6N-CS10	10P 20

TBU-10N

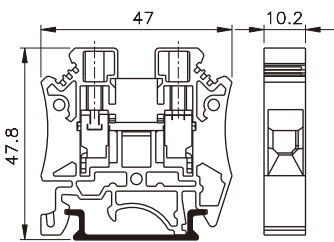
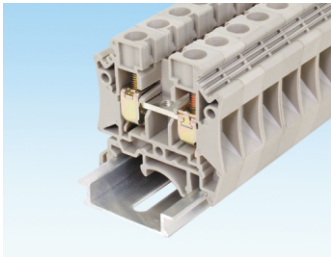

TBU-16N

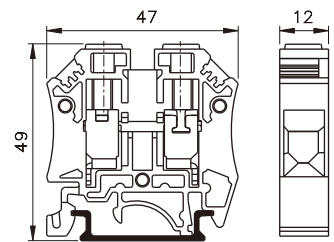
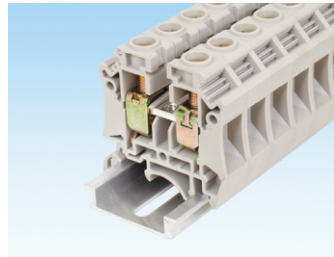

TBU-35N

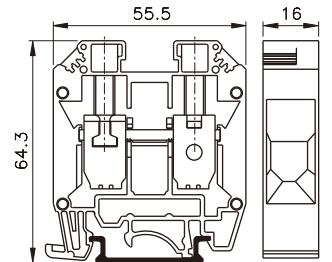
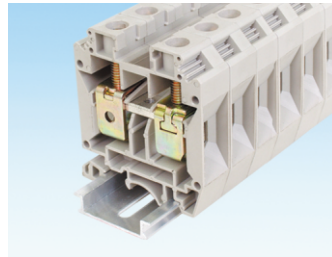

TBU-50N

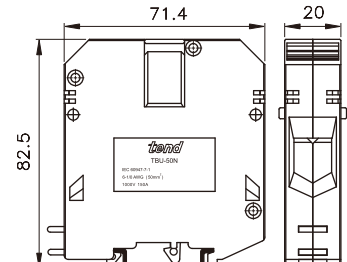
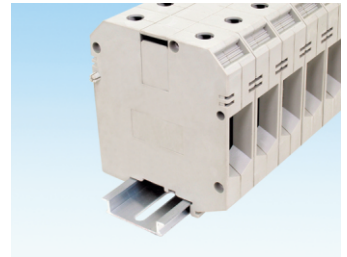

IEC
57A
800V
10mm <sup>2</sup>
16-6 AWG
16-6 AWG
5KV
16kgf.cm
M4
10~12mm

IEC
76A
800V
16mm <sup>2</sup>
14-6AWG
14-6AWG
5KV
30kgf.cm
M5
10~12mm

IEC
125A
800V
35mm <sup>2</sup>
12-2 AWG
12-2AWG
5KV
50kgf.cm
M6
15~20mm

IEC
150A
1000V
50mm <sup>2</sup>
6-1/0AWG
6-1/0AWG
5KV
50kgf.cm
M6
25~30mm

型號	包裝數
TBU10N-A	100
TBU2.5N-F	50
TBU2.5N-H	100
TBR-N(鋁)/TBR-S(鋼)	1M/條
TBU10N-CU2 2P	50
TBU10N-CU3 3P	50
TBU10N-CU4 4P	50
TBU10N-CU10 10P	20
TBU10N-CS2 2P	50
TBU10N-CS3 3P	50
TBU10N-CS4 4P	50
TBU10N-CS10 10P	20

型號	包裝數
TBU10N-A	100
TBU2.5N-F	50
TBU2.5N-H	100
TBR-N(鋁)/TBR-S(鋼)	1M/條
TBU16N-CU2 2P	50
TBU16N-CU3 3P	50
TBU16N-CU4 4P	50
TBU16N-CU10 10P	10
TBU16N-CS2 2P	50
TBU16N-CS3 3P	50
TBU16N-CS4 4P	50
TBU16N-CS10 10P	10

型號	包裝數
TBU10N-A	100
TBU2.5N-F	50
TBU2.5N-H	100
TBR-N(鋁)/TBR-S(鋼)	1M/條
TBU35N-CU2 2P	50
TBU35N-CU3 3P	50
TBU35N-CU4 4P	50
TBU35N-CU10 10P	10
TBU35N-CS2 2P	50
TBU35N-CS3 3P	50
TBU35N-CS4 4P	50
TBU35N-CS10 10P	10

型號	包裝數
TBU50N-A	50
TBU35N-F	50
TBR-N(鋁)/TBR-S(鋼)	1M/條



## ■ 特徵

- TBE系列的端子盤可配在TBR-N導軌上。
- 採用框式壓線,材料為經淬火硬化並經鍍鋅鈍化的優質鋼板。
- 可搭配適合的短路片及標示牌,產品的設計符合IEC60947-7-2等國際標準。

TBE-2.5N

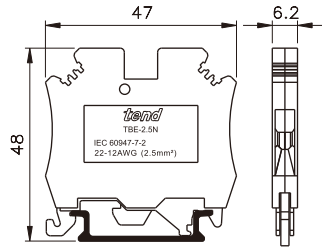
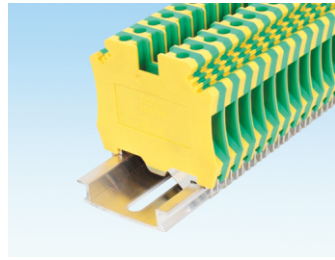

TBE-4N

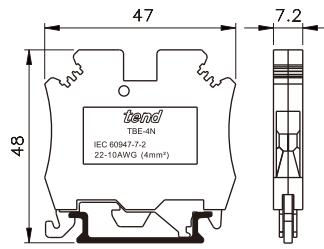
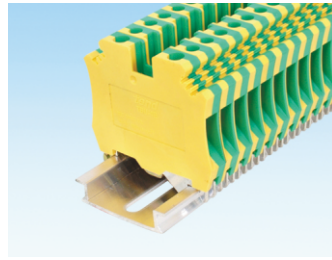

TBE-6N

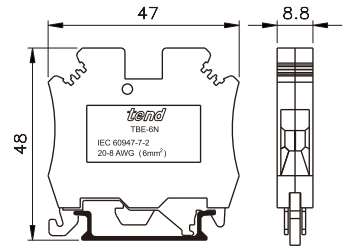
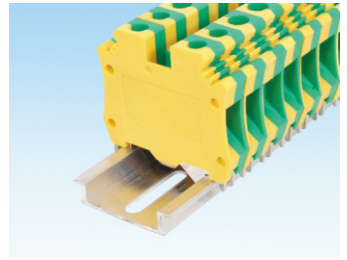

## 規格

額定電流

IEC

24A

IEC

32A

IEC

41A

電線截面積

2.5mm<sup>2</sup>

4mm<sup>2</sup>

6mm<sup>2</sup>

單芯線

22-12AWG

22-10AWG

20-8 AWG

多芯線

22-12AWG

22-10AWG

20-8 AWG

耐電壓

5KV

5KV

5KV

扭力

4kgf.cm

6kgf.cm

10kgf.cm

螺絲

M2.6

M3

M3.5

剝線長度

10~12mm

10~12mm

10~12mm

## 配件

標示牌



型號

包裝數

TBU4N-A

100

型號

包裝數

TBU4N-A

100

型號

包裝數

TBU6N-A

100

擋片



TBU2.5N-F

50

TBU2.5N-F

50

TBU2.5N-F

50

適用導軌



TBR-N(鋁)/TBR-S(鋼)

1M/條

TBR-N(鋁)/TBR-S(鋼)

1M/條

TBR-N(鋁)/TBR-S(鋼)

1M/條



## ■ 特徵

- TBE系列的端子盤可配在TBR-N導軌上。
- 採用框式壓線,材料為經淬火硬化並經鍍鋅鈍化的優質鋼板。
- 可搭配適合的短路片及標示牌,產品的設計符合IEC60947-7-2等國際標準。

TBE-10N

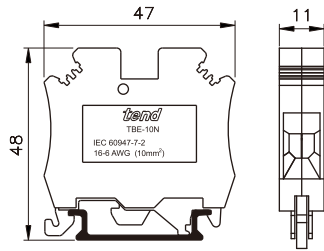
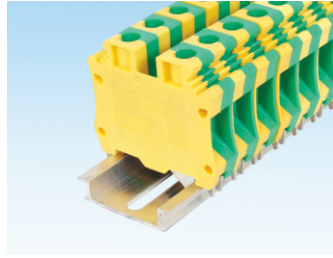

TBE-16N

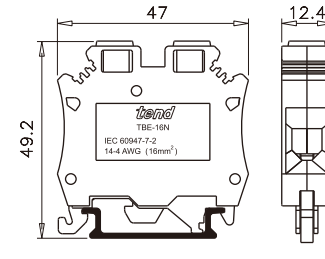
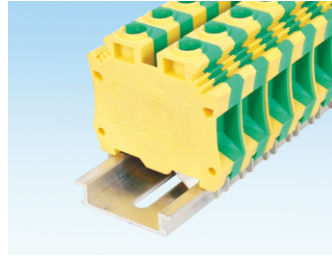

TBE-35N

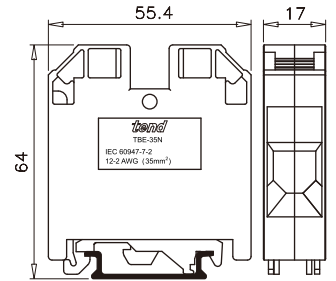
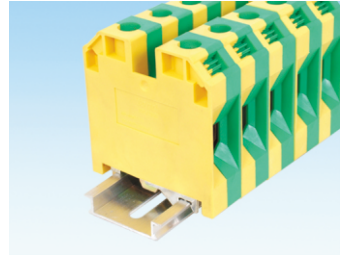

## 規格

額定電流

IEC

57A

電線截面積

10mm<sup>2</sup>

單芯線

16-6AWG

多芯線

16-6 AWG

耐電壓

5KV

扭力

16kgf.cm

螺絲

M4

剝線長度

10~12mm

## 配件

標示牌



型號

TBU10N-A

包裝數

100

擋片



TBU2.5N-F

50

適用導軌



TBR-N(鋁)/TBR-S(鋼) 1M/條

IEC

76A

16mm<sup>2</sup>

14-6 AWG

14-6AWG

5KV

30kgf.cm

M5

10~12mm

型號

TBU10N-A

包裝數

100

TBU2.5N-F

50

TBR-N(鋁)/TBR-S(鋼) 1M/條

IEC

125A

35mm<sup>2</sup>

12-2AWG

12-2AWG

5KV

50kgf.cm

M6

15~20mm

型號

TBU10N-A

包裝數

100

TBU35N-F

50

TBR-N(鋁)/TBR-S(鋼) 1M/條



## ■ 特徵

● TBT開刀式及TBFV(H)系列的保險絲端子盤可裝配在TBR-N導軌上。

● 採用框式壓線,材料為經淬火硬化並經鍍鋅鈍化的優質鋼板。

● 可搭配適合的標示牌,產品的設計符合IEC60947-7-3等國際標準。

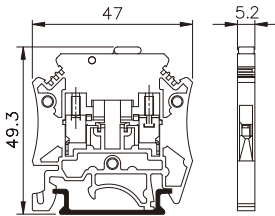
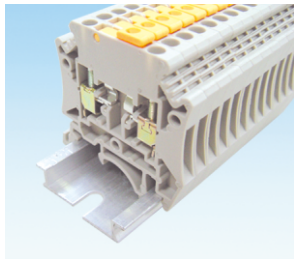
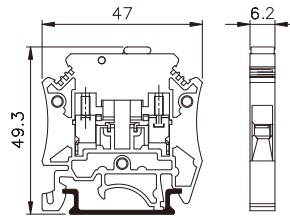
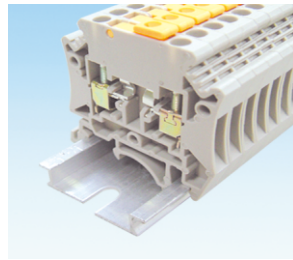
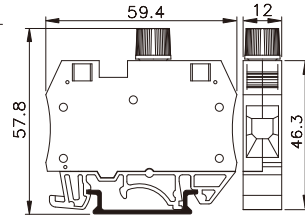
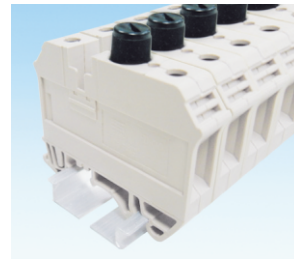
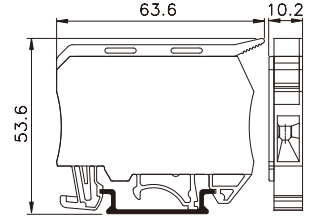
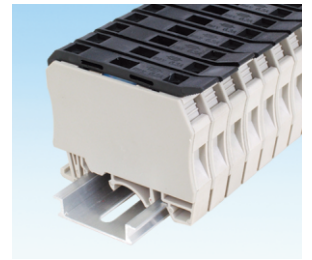
**TBT-2.5N(開刀式)**

**TBT-4N(開刀式)**

**TBFV(立式保險絲)  
TBFV-1/TBFV-2(附LED)**

**TBFH(臥式保險絲)  
TBFH-1/TBFH-2(附LED)**

規格	IEC		IEC		IEC		IEC	
額定電流	10A		16A		10A		6.3A	
額定電壓	400V		400V		500V		400V	
電線截面積	2.5mm <sup>2</sup>		4mm <sup>2</sup>		10mm <sup>2</sup>		4mm <sup>2</sup>	
單芯線	22-12AWG		22-10AWG		16-6AWG		22-10AWG	
多芯線	22-12AWG		22-10AWG		16-6AWG		22-10AWG	
耐電壓	5KV		5KV		5KV		5KV	
扭力	4kgf.cm		6kgf.cm		16kgf.cm		6kgf.cm	
螺絲	M2.6		M3		M4		M3	
剝線長度	10~12mm		10~12mm		10~12mm		10~12mm	
保險絲規格	——		——		Ø5X20		Ø5X20/Ø5X25	
配件	型號	包裝數	型號	包裝數	型號	包裝數	型號	包裝數
標示牌	TBU2.5N-A	100	TBU4N-A	100	TBU10N-A	100	TBU6N-A	100
擋片	TBU2.5N-F	50	TBU2.5N-F	50	TBU2.5N-F	50	TBU2.5N-F	50
側蓋	TBU2.5N-H	100	TBU2.5N-H	100	——	——	——	——
適用導軌	TBR-N(鋁)/TBR-S(鋼)1M/條		TBR-N(鋁)/TBR-S(鋼)1M/條		TBR-N(鋁)/TBR-S(鋼)1M/條		TBR-N(鋁)/TBR-S(鋼)1M/條	
上連接片	——		——		TBU16N-CU2	2P 50	——	
	——		——		TBU16N-CU3	3P 50	——	
側連接片	TBU2.5N-CS2	2P 50	TBU4N-CS2	2P 50	TBU16N-CS2	2P 50	——	
	TBU2.5N-CS3	3P 50	TBU4N-CS3	3P 50	TBU16N-CS3	3P 50	——	
	TBU2.5N-CS4	4P 50	TBU4N-CS4	4P 50	TBU16N-CS4	4P 50	——	
	TBU2.5N-CS10	10P 20	TBU4N-CS10	10P 20	TBU16N-CS10	10P 10	——	
規格	說 明							
附LED	TBFV-1/TBFH-1:10~30VAC/DC				TBFV-2/TBFH-2:110~250VAC			

## ■ 配 件

材質： PA66尼龍  
 工作溫度範圍： -40°C~+100°C

注：包裝數量100.PCS(10PCS 為一條)  
 TBU-50N為單PCS(無整條)

### 標示牌

(TBU-2.5N用)	(TBU-4N用)	(TBU-6N用)	(TBU-10N,TB-16N,TB-35N用)	說明	包裝數
型號	型號	型號	型號		
TBU2.5N-A	TBU4N-A	TBU6N-A	TBU10N-A	空白	100
TBU2.5N-A1	TBU4N-A1	TBU6N-A1	TBU10N-A1	1	100
TBU2.5N-A2	TBU4N-A2	TBU6N-A2	TBU10N-A2	2	100
TBU2.5N-A3	TBU4N-A3	TBU6N-A3	TBU10N-A3	3	100
TBU2.5N-A4	TBU4N-A4	TBU6N-A4	TBU10N-A4	4	100
TBU2.5N-A5	TBU4N-A5	TBU6N-A5	TBU10N-A5	5	100
TBU2.5N-A6	TBU4N-A6	TBU6N-A6	TBU10N-A6	6	100
TBU2.5N-A7	TBU4N-A7	TBU6N-A7	TBU10N-A7	7	100
TBU2.5N-A8	TBU4N-A8	TBU6N-A8	TBU10N-A8	8	100
TBU2.5N-A0	TBU4N-A0	TBU6N-A0	TBU10N-A0	0	100
TBU2.5N-A18	TBU4N-A18	TBU6N-A18	TBU10N-A18	18	100
TBU2.5N-A21	TBU4N-A21	TBU6N-A21	TBU10N-A21	21	100
TBU2.5N-A22	TBU4N-A22	TBU6N-A22	TBU10N-A22	22	100
TBU2.5N-A23	TBU4N-A23	TBU6N-A23	TBU10N-A23	23	100
TBU2.5N-A24	TBU4N-A24	TBU6N-A24	TBU10N-A24	24	100
TBU2.5N-A41	TBU4N-A41	TBU6N-A41	TBU10N-A41	41	100
TBU2.5N-A42	TBU4N-A42	TBU6N-A42	TBU10N-A42	42	100
TBU2.5N-AR	TBU4N-AR	TBU6N-AR	TBU10N-AR	R	100
TBU2.5N-AS	TBU4N-AS	TBU6N-AS	TBU10N-AS	S	100
TBU2.5N-AT	TBU4N-AT	TBU6N-AT	TBU10N-AT	T	100
TBU2.5N-AU-1	TBU4N-AU-1	TBU6N-AU-1	TBU10N-AU-1	U	100
TBU2.5N-AV	TBU4N-AV	TBU6N-AV	TBU10N-AV	V	100
TBU2.5N-AW	TBU4N-AW	TBU6N-AW	TBU10N-AW	W	100
TBU2.5N-AG	TBU4N-AG	TBU6N-AG	TBU10N-AG	G	100
TBU2.5N-A0110	TBU4N-A0110	TBU6N-A0110	TBU10N-A0110	1~10	100
TBU2.5N-A1120	TBU4N-A1120	TBU6N-A1120	TBU10N-A1120	11~20	100
TBU2.5N-A2130	TBU4N-A2130	TBU6N-A2130	TBU10N-A2130	21~30	100
TBU2.5N-A3140	TBU4N-A3140	TBU6N-A3140	TBU10N-A3140	31~40	100
TBU2.5N-A4150	TBU4N-A4150	TBU6N-A4150	TBU10N-A4150	41~50	100
TBU2.5N-AL	TBU4N-AL	TBU6N-AL	TBU10N-AL	L1,L2,L3,N,PE	100
TBU2.5N-AU	TBU4N-AU	TBU6N-AU	TBU10N-AU	U,V,W,N ⊥	100

### 標示牌(TBU-50N,70N,95N,150N用)

1	1	1	1	1	1	1	1	1	1
1	2	3	4	5	6	7	8	9	10
L1	L2	L3	N	PE	L1	L2	L3	N	PE
U	V	W	N	⊥	U	V	W	N	⊥

型號	說明	包裝數
TBU50N-A	空白	50
TBU50N-A1	1	50
TBU50N-A2	2	50
TBU50N-A3	3	50
TBU50N-A4	4	50
TBU50N-A5	5	50
TBU50N-A6	6	50
TBU50N-A7	7	50
TBU50N-A8	8	50
TBU50N-A0	0	50
TBU50N-AL1	L1	50
TBU50N-AL2	L2	50
TBU50N-AL3	L3	50
TBU50N-AN	N	50
TBU50N-APE	PE	50
TBU50N-AU	U	50
TBU50N-AV	V	50
TBU50N-AW	W	50
TBU50N-AE	⊥	50

## ■ 配件

### TBU N-CU 上連接片

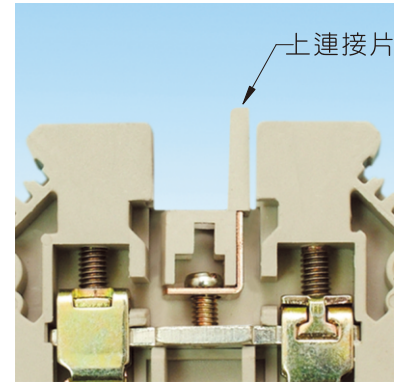
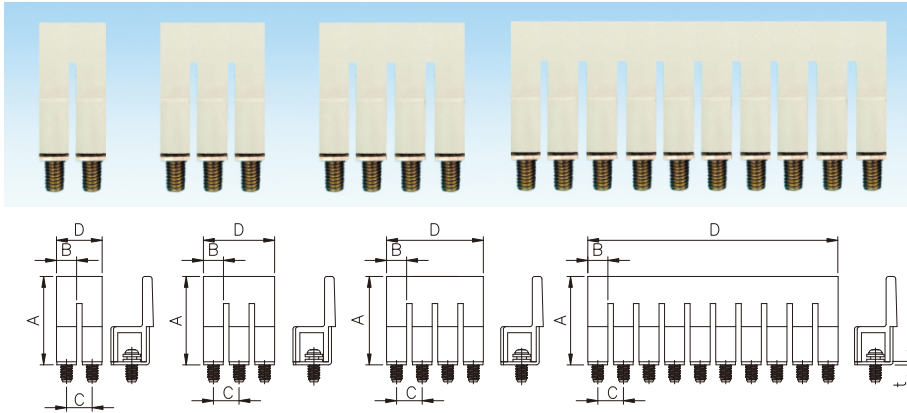

上連接片型號	P數	適用端子盤	包裝數量	尺寸(見上圖)					上連接片型號	P數	適用端子盤	包裝數量	尺寸(見上圖)				
				A	B	C	D	t					A	B	C	D	t
TBU2.5N-CU2	2	TBU-2.5N	50	17.8	4	5.1	9.1	0.6	TBU10N-CU2	2	TBU-10N	50	24.9	8	10.2	18.2	1
TBU2.5N-CU3	3	TBU-2.5N	50	17.8	4	5.1	14.2	0.6	TBU10N-CU3	3	TBU-10N	50	24.9	8	10.2	28.4	1
TBU2.5N-CU4	4	TBU-2.5N	50	17.8	4	5.1	19.3	0.6	TBU10N-CU4	4	TBU-10N	50	24.9	8	10.2	38.6	1
TBU2.5N-CU10	10	TBU-2.5N	20	17.8	4	5.1	49.9	0.6	TBU10N-CU10	10	TBU-10N	20	24.9	8	10.2	99.8	1
TBU4N-CU2	2	TBU-4N	50	18.2	4.5	6.2	10.7	1	TBU16N-CU2	2	TBU-16N	50	26.2	9.4	12	21.4	1
TBU4N-CU3	3	TBU-4N	50	18.2	4.5	6.2	16.9	1	TBU16N-CU3	3	TBU-16N	50	26.2	9.4	12	33.4	1
TBU4N-CU4	4	TBU-4N	50	18.2	4.5	6.2	23.1	1	TBU16N-CU4	4	TBU-16N	50	26.2	9.4	12	45.4	1
TBU4N-CU10	10	TBU-4N	20	18.2	4.5	6.2	60.3	1	TBU16N-CU10	10	TBU-16N	10	26.2	9.4	12	117.4	1
TBU6N-CU2	2	TBU-6N	50	18.2	6.2	8.2	14.4	1	TBU35N-CU2	2	TBU-35N	50	26.8	11.5	15.9	27.4	1.6
TBU6N-CU3	3	TBU-6N	50	18.2	6.2	8.2	22.6	1	TBU35N-CU3	3	TBU-35N	50	26.8	11.5	15.9	43.3	1.6
TBU6N-CU4	4	TBU-6N	50	18.2	6.2	8.2	30.8	1	TBU35N-CU4	4	TBU-35N	50	26.8	11.5	15.9	59.2	1.6
TBU6N-CU10	10	TBU-6N	20	18.2	6.2	8.2	80.0	1	TBU35N-CU10	10	TBU-35N	10	26.8	11.5	15.9	154.6	1.6

### TBU N-CS 側連接片

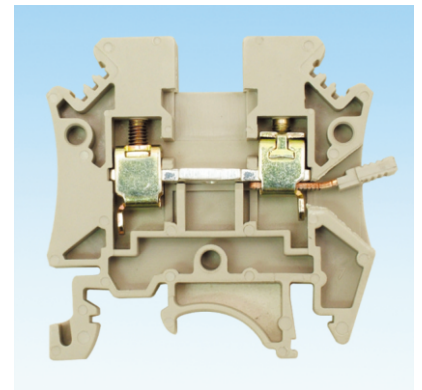
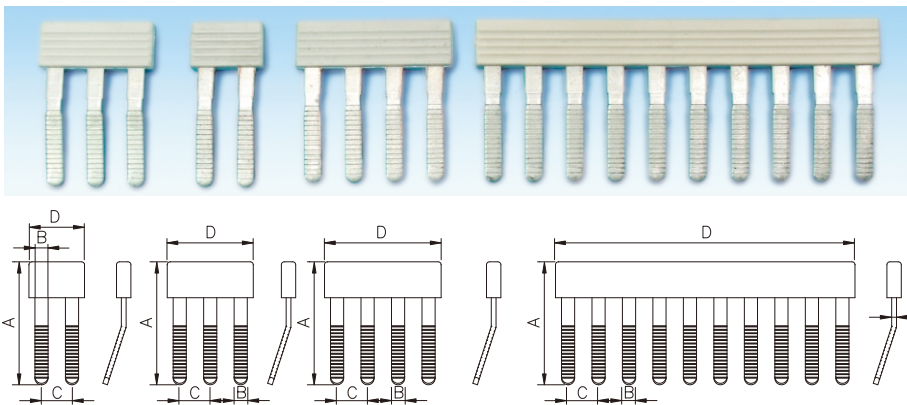

側連接片型號	P數	適用端子盤	包裝數量	尺寸(見上圖)					側連接片型號	P數	適用端子盤	包裝數量	尺寸(見上圖)				
				A	B	C	D	t					A	B	C	D	t
TBU2.5N-CS2	2	TBU-2.5N	50	20.6	2.2	5.1	9.3	0.8	TBU10N-CS2	2	TBU-10N	50	29.4	5.4	10.2	18.4	1.6
TBU2.5N-CS3	3	TBU-2.5N	50	20.6	2.2	5.1	14.4	0.8	TBU10N-CS3	3	TBU-10N	50	29.4	5.4	10.2	28.6	1.6
TBU2.5N-CS4	4	TBU-2.5N	50	20.6	2.2	5.1	19.5	0.8	TBU10N-CS4	4	TBU-10N	50	29.4	5.4	10.2	38.8	1.6
TBU2.5N-CS10	10	TBU-2.5N	20	20.6	2.2	5.1	50.1	0.8	TBU10N-CS10	10	TBU-10N	20	29.4	5.4	10.2	100	1.6
TBU4N-CS2	2	TBU-4N	50	21.5	2.5	6.2	10.7	1	TBU16N-CS2	2	TBU-16N	50	31	6.6	12	21	1.6
TBU4N-CS3	3	TBU-4N	50	21.5	2.5	6.2	16.9	1	TBU16N-CS3	3	TBU-16N	50	31	6.6	12	33	1.6
TBU4N-CS4	4	TBU-4N	50	21.5	2.5	6.2	23.1	1	TBU16N-CS4	4	TBU-16N	50	31	6.6	12	45	1.6
TBU4N-CS10	10	TBU-4N	20	21.5	2.5	6.2	60.3	1	TBU16N-CS10	10	TBU-16N	10	31	6.6	12	117	1.6
TBU6N-CS2	2	TBU-6N	50	23.8	3.6	8.2	14.8	1.2	TBU35N-CS2	2	TBU-35N	50	37.2	8.4	15.9	29.6	1.6
TBU6N-CS3	3	TBU-6N	50	23.8	3.6	8.2	23	1.2	TBU35N-CS3	3	TBU-35N	50	37.2	8.4	15.9	45.6	1.6
TBU6N-CS4	4	TBU-6N	50	23.8	3.6	8.2	31.2	1.2	TBU35N-CS4	4	TBU-35N	50	37.2	8.4	15.9	61.6	1.6
TBU6N-CS10	10	TBU-6N	20	23.8	3.6	8.2	80.4	1.2	TBU35N-CS10	10	TBU-35N	10	37.2	8.4	15.9	157.6	1.6



## ■ 配件

TBU2.5N-H  
TBU-2.5N側蓋 (適用於TBU-2.5N~16N)

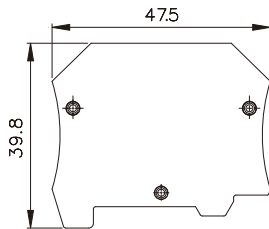

TBU35N-H  
TBU-35N側蓋 (適用於TBU-35N)

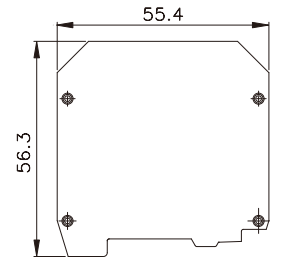
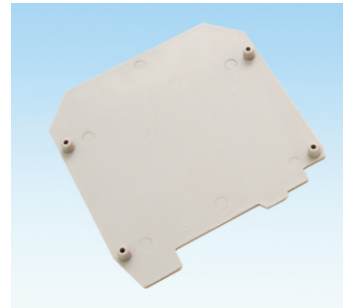

TBU2.5N-F  
TBU-2.5N擋片 (適用於2.5N~16N)

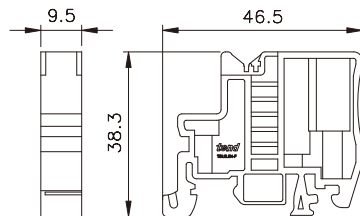
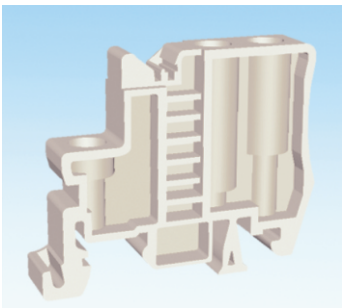

TBU35N-F  
TBU-35N擋片 (適用於35N~150N)

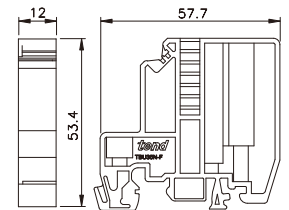
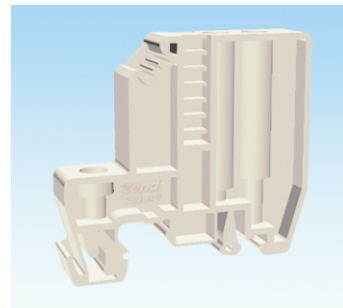

TBU2.5N-K  
TBU-2.5N分隔片 (適用於TBU-2.5N~16N)

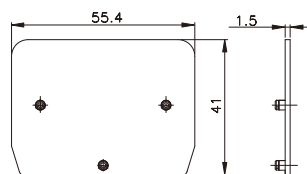

TBU2.5N-B  
TBU-2.5N擋片標示牌

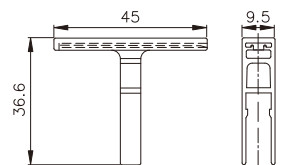

TBR-N 鋁軌 TBR-S 鋼軌

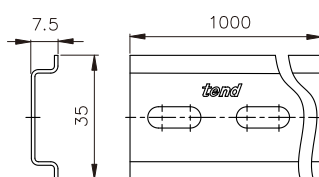
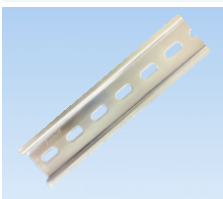
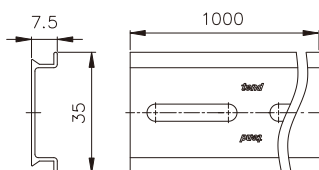

TBU2.5N-T  
TBU-2.5N 標記牌

